

[®]
LITE
MEGGA

CIRCA

GIANT^SCOOP LED

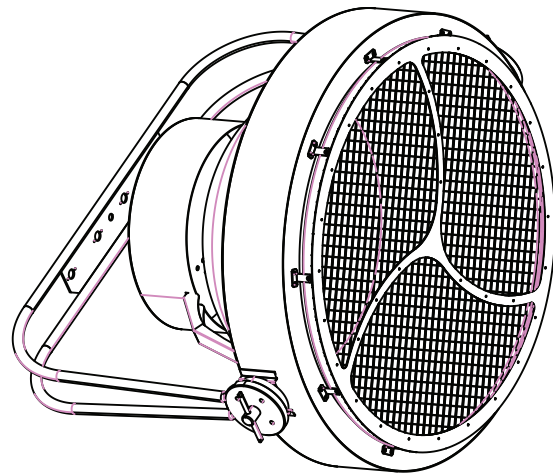

USER MANUAL

Table of Contents

Safety Information	2
What's Included	2
Specifications	3
Main Power Connection	4
DMX Connection	4
Display Settings	5
DMX Profile	8
Size And Weight	12
Segment	13
Installation	13
Warranty	14
Customer Service	15

Check that the unit has not been damaged during transport.



Read all cautions and warnings
prior to operation of this
equipment

Protection Against Fire



1. Maintain a minimum of 1 foot distance from any type of flame.
2. Fixture is NOT designed outdoor use.
3. Do not install the unit too close to a heat source.
4. Make sure cables are properly secured.
5. Maximum surface operating temperature: 200°.

Protection Against Electrical Fire

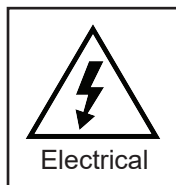

1. Disconnect power before servicing.
2. For connection to main power supply, proceed to page 4.
3. The power supply must be earthed (electronically grounded).
4. This fixture must not be left on for long periods of time.

Protection Against Mechanical Hazards

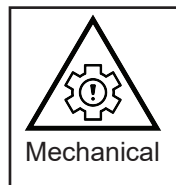

1. Use secondary safety chain when hanging unit.
2. Use quality clamps or bolts when positioning unit.
3. Do not open unit while it is on. Risk of electrical shock.

What is Included

1pc Circa Giant Fixture
1pc Power Cable
2pc Quick Release Clamp Mount
1pc 1pc User Manual
1pc Road Case

Specifications

Part Numbers

Fixture ID

5202=Circa Giant

Mechanical Specifications

Housing:	Sheet Metal
Mounting System:	2 Quick Release Clamp Mounts, Hanging Yoke
Power Connection:	Input: Seetronics SAC3MPX Output: Seetronics SAC3FX Cable: Seetronics SAC3FX to Nema 5/15
LED Angle:	140° (outer ring)
Signal Connection:	5 Pin XLR In and Out
Thermal:	Maximum ambient temperature 115°F Maximum surface temperature 135°F
Weight:	51lb
Size:	39.37" X 27.92" X 34"

Electrical Specifications

LED Quantity:	384 RGB Outer Ring, 288 Inner Ring, 80 Warm White + Amber Center, 180 Warm White Reflective
LED Watts:	0.8 Watts each
Fuse:	5x20mm F10AL250V
Power Input:	110-240VAC 50/60Hz
Scan Rate:	7000Hz
Power Consumption:	445 Watts 5.43Amps @110V

Control & Programming

Protocol:	DMX 512
DMX 5 Modes:	Mode 1 2Ch Dimmer, Macro Mode 2 3Ch Dimmer, Warm White, Amber Mode 3 17Ch Dimmer, Outer R, G, B, Macro, Macro Speed, Outer Strobe, Inner R, G, B, Macro, Macro Speed, Inner Strobe, Center Warm White, Amber, Reflective Center Warm White, Center Strobe Mode 4 52Ch Dimmer, Outer RGB X8, Inner RGB X8, Center Warm White, Amber, Reflective Warm White Mode 5 55Ch Dimmer, Outer RGB X8, Outer Strobe, Inner RGB X8, Inner Strobe, Center Warm White, Amber, Reflective Warm White, Center Strobe
Operating Mode:	Display Control

Main Power Connection

Caution!

1. Do not connect fixture to a dimmer system.
2. This unit must be earthed. (Electronically grounded)
3. Replace fuse only with the specified type and rating. (F10AL250V)
4. This device is equipped with auto switching power supply that will allow the fixture to work from 100-240V AC 50/60Hz
5. This device can power link 2 units on 110V power.

Cable USA	Cable EU	110V	220V
Black	Brown	Live	Live
White	Light Blue	Neutral	Live
Green	Yellow / Green	Ground	Ground

DMX-512 Connection

The fixture is equipped with 3 and 5 pin XLR Sockets for DMX input and output connection. The sockets are wired in parallel. Only use a shielded twisted pair cable designed for RS-485 and 3 or 5 pin XLR plugs and connectors in order to connect the controller with the fixture or the fixture with another.

DMX - Input

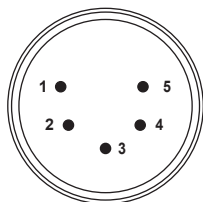

1. Shield (Grd)
2. Signal (-)
3. Signal (+)
N/A
N/A

DMX - Output

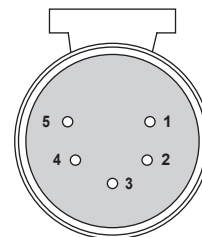

Caution!

On the last fixture the DMX signal needs to be terminated with a terminator. Pre-manufactured terminator are available for purchase from your Mega-Lite dealer item #P-DMX-T.

Display Control

The control board on the rear of the fixture is your interface to access and control all the functions on the unit. It's LCD display gives you a code view of the options and functions. The following will explain each function.

Mega Lite
Circa Giant Scoop
V1.7

● ● ● ●
ESC DOWN UP ENTER

Address
001

DMX On

DMX Address: Press **Enter** to select the DMX start channel. Use the **Up/Down** keys to select from (001 to 512). Press **Enter** to confirm the setting. Press **ESC** to return to Main Menu.
(Note: Display must be on Main Menu for fixture to operate on DMX Mode)

Main Menu
>Channel Mode
LED Dimmer
LED Strobe

Channel Mode: Press **Enter** to select the fixtures DMX operational mode. Use the **Up/Down** buttons to select preferred fixture profile mode

- 2Ch** Dimmer, Macro
- 3Ch** Dimmer, Warm White, Amber
- 17Ch** Dimmer, Outer R, G, B, Macro, Macro Speed, Outer Strobe, Inner R, G, B, Macro, Macro Speed, Inner Strobe, Center Warm White, Amber, Reflective Center Warm White, Center Strobe
- 52Ch** Dimmer, Outer RGB X8, Inner RGB X8, Center Warm White, Amber, Reflective Warm White
- 55Ch** Dimmer, Outer RGB X8, Outer Strobe, Inner RGB X8, Inner Strobe, Center Warm White, Amber, Reflective Warm White, Center Strobe

Main Menu
Channel Mode
>**LED Dimmer**
LED Strobe

LED Dimmer: This function allows for manual dimming of each led via display. For Channel Function please refer to DMX Profile for 52 Channel mode

Main Menu
Channel Mode
LED Dimmer
>**LED Strobe**

LED Strobe: This function allows you to strobe the LED's. Press **Enter** use the **Up/Down** Keys to select desired Strobe Speed (15 Options from slow to fast)
(Note: LED Dimmer Function intensity must be set prior in the LED Dimmer Function)

Main Menu
>**Fan Test**
Auto Mode
Auto Speed

Fan Test: Press Up or Down to select from Center Fan or Ring Fan Test for function.

Main Menu
Fan Test
>**Auto Mode**
Auto Speed

Auto Mode: Press **Enter** use the **Up/Down** buttons to select from 6 different preset programs.

Main Menu
Fan Test
Auto Mode
>**Auto Speed**

Auto Speed: Press **Enter** use the **Up/Down** buttons to select from 5 different speeds for the Auto preset programs.

(Note Auto Mode programs must be selected)

Main Menu
Auto Speed
>**Temperature**
Setting

Temperature: This fixture is equipped with internal fan sensors. Once the fixture reaches 96 the fans will engage.

Main Menu
Auto Speed
Temperature
>**Setting**

Settings: Preferred user setting options

Setting
>**OLED Back Light**
DMX Fail
Dimmer Settings

OLED Back Light: To turn off display screen after 2 minutes of no use select **Disable**. To enable the screen to remain on when is use select **Enable**.

Setting
>**DMX Fail**
Dimmer Settings
Factory Reset

DMX Fail: If DMX Signal is lost select **Enable** to have the last DMX command hold. Select **Disable** option if you want to have fixture setting go to off position.

Setting
DMX Fail
>**Dimmer Settings**
Factory Reset

Dimmer Setting: Select Dimmer Setting to be used for dimming type when used in Ch3 mode.

Options
Linear
Square Law
Inv. Square Law
S Type

Setting
DMX Fail
Dimmer Settings
>**Factory Reset**

Factory Reset:

False: To return to menu
True: To set fixture to original factory settings

Circa Giant Scoop LED 2 Ch Mode

DMX Channel	Function	Description	Value	Init
1	Dimmer	Dimmer Off to Full	0-255	255
		No Function	0-41	
2	Macro	Macro 1 (slow to fast)	42-83	0
		Macro 2 (slow to fast)	84-125	
		Macro 3 (slow to fast)	126-167	
		Macro 4 (slow to fast)	168-209	
		Macro 5 (slow to fast)	210-255	

Circa Giant Scoop LED 3 Ch Mode

DMX Channel	Function	Description	Value	Init
1	Dimmer	Dimmer Off to Full	0-255	255
2	LED Color	Center & Back Warm White	0-255	255
3	LED Color	Center Amber	0-255	255

Circa Giant Scoop LED 17 Ch Mode

DMX Channel	Function	Description	Value	Init
1	Dimmer	Master Dimmer Off to Full	0-255	255
2	LED Color	Outer Red LED intensity	0-255	255
3	LED Color	Outer Green LED Intensity	0-255	255
4	LED Color	Outer Blue LED Intensity	0-255	255
5	Outer Ring Macro (Select Color)	No Function	0-1	0
		Fade Clockwise	2-24	
		Fade Counter Clockwise	25-49	
		Snap Clockwise	50-74	
		Snap Counter Clockwise	75-99	
		2468 then 1357 Fade	100-124	
		2468 then 1357 Snap	125-149	
		Bounce Fade 12345678765432	150-174	
		Bounce Snap 12345678765432	175-199	
		Top to Bottom 18,27,34,56,34,27	200-224	
Side to Side 23,14,85,76	225-255			
6	Macro Speed	Outer Ring Macro Speed	0-255	0
7	Outer Ring Strobe	No Function	0-1	0
		Strobe (slow to fast)	2-127	
		Strobe Pulse (slow to fast)	128-170	
		Random Strobe All (slow to fast)	171-213	
		Random 1-8 Strobe (slow to fast)	214-255	
8	LED Color	Inner Red LED intensity	0-255	255
9	LED Color	Inner Green LED Intensity	0-255	255
10	LED Color	Inner Blue LED Intensity	0-255	255
11	Inner Ring Macro (Select Color)	No Function	0-1	0
		Fade Clockwise	2-24	
		Fade Counter Clockwise	25-49	
		Snap Clockwise	50-74	
		Snap Counter Clockwise	75-99	
		2468 then 1357 Fade	100-124	
		2468 then 1357 Snap	125-149	
		Bounce Fade 12345678765432	150-174	
		Bounce Snap 12345678765432	175-199	
		Top to Bottom 18,27,34,56,34,27	200-224	
Side to Side 23,14,85,76	225-255			
12	Macro Speed	Inner Ring Macro Speed	0-255	0
13	Inner Ring Strobe	No Function	0-1	0
		Strobe (slow to fast)	2-127	
		Strobe Pulse (slow to fast)	128-170	
		Random Strobe All (slow to fast)	171-213	
		Random 1-8 Strobe (slow to fast)	214-255	
14	Warm White	Center Warm White	0-255	255
15	Amber	Center Amber	0-255	255
16	Warm White	Center Reflective Warm White	0-255	255
17	Center Strobe	No Function	0-1	0
		Strobe (slow to fast)	2-127	
		Strobe Pulse (slow to fast)	128-170	
		Random Strobe All (slow to fast)	171-213	
		Random Strobe 1-3 (slow to fast)	214-255	

DMX Profile

Circa Giant Scoop LED 52 Ch Mode

DMX Channel	Function	Description	Value	Init
1	Dimmer	Master Dimmer Off to Full	0-255	255
2	LED Color	Outter 1 Red LED intensity	0-255	0
3	LED Color	Outter 1 Green LED intensity	0-255	0
4	LED Color	Outter 1 Blue LED intensity	0-255	0
5	LED Color	Outter 2 Red LED intensity	0-255	0
6	LED Color	Outter 2 Green LED intensity	0-255	0
7	LED Color	Outter 2 Blue LED intensity	0-255	0
8	LED Color	Outter 3 Red LED intensity	0-255	0
9	LED Color	Outter 3 Green LED intensity	0-255	0
10	LED Color	Outter 3 Blue LED intensity	0-255	0
11	LED Color	Outter 4 Red LED intensity	0-255	0
12	LED Color	Outter 4 Green LED intensity	0-255	0
13	LED Color	Outter 4 Blue LED intensity	0-255	0
14	LED Color	Outter 5 Red LED intensity	0-255	0
15	LED Color	Outter 5 Green LED intensity	0-255	0
16	LED Color	Outter 5 Blue LED intensity	0-255	0
17	LED Color	Outter 6 Red LED intensity	0-255	0
18	LED Color	Outter 6 Green LED intensity	0-255	0
19	LED Color	Outter 6 Blue LED intensity	0-255	0
20	LED Color	Outter 7 Red LED intensity	0-255	0
21	LED Color	Outter 7 Green LED intensity	0-255	0
22	LED Color	Outter 7 Blue LED intensity	0-255	0
23	LED Color	Outter 8 Red LED intensity	0-255	0
24	LED Color	Outter 8 Green LED intensity	0-255	0
25	LED Color	Outter 8 Blue LED intensity	0-255	0
26	LED Color	Inner 1 Red LED intensity	0-255	0
27	LED Color	Inner 1 Green LED intensity	0-255	0
28	LED Color	Inner 1 Blue LED intensity	0-255	0
29	LED Color	Inner 2 Red LED intensity	0-255	0
30	LED Color	Inner 2 Green LED intensity	0-255	0
31	LED Color	Inner 2 Blue LED intensity	0-255	0
32	LED Color	Inner 3 Red LED intensity	0-255	0
33	LED Color	Inner 3 Green LED intensity	0-255	0
34	LED Color	Inner 3 Blue LED intensity	0-255	0
35	LED Color	Inner 4 Red LED intensity	0-255	0
36	LED Color	Inner 4 Green LED intensity	0-255	0
37	LED Color	Inner 4 Blue LED intensity	0-255	0
38	LED Color	Inner 5 Red LED intensity	0-255	0
39	LED Color	Inner 5 Green LED intensity	0-255	0
40	LED Color	Inner 5 Blue LED intensity	0-255	0
41	LED Color	Inner 6 Red LED intensity	0-255	0
42	LED Color	Inner 6 Green LED intensity	0-255	0
43	LED Color	Inner 6 Blue LED intensity	0-255	0
44	LED Color	Inner 7 Red LED intensity	0-255	0
45	LED Color	Inner 7 Green LED intensity	0-255	0
46	LED Color	Inner 7 Blue LED intensity	0-255	0
47	LED Color	Inner 8 Red LED intensity	0-255	0
48	LED Color	Inner 8 Green LED intensity	0-255	0
49	LED Color	Inner 8 Blue LED intensity	0-255	0
50	LED Color	Center Warm White	0-255	0
51	LED Color	Center Amber	0-255	0
52	LED Color	Reflective Warm White	0-255	0

DMX Profile

Circa Giant Scoop LED 55 Ch Mode				
DMX Channel	Function	Description	Value	Init
1	Dimmer	Master Dimmer Off to Full	0-255	255
2	LED Color	Outer 1 Red LED intensity	0-255	0
3	LED Color	Outer 1 Green LED intensity	0-255	0
4	LED Color	Outer 1 Blue LED intensity	0-255	0
5	LED Color	Outer 2 Red LED intensity	0-255	0
6	LED Color	Outer 2 Green LED intensity	0-255	0
7	LED Color	Outer 2 Blue LED intensity	0-255	0
8	LED Color	Outer 3 Red LED intensity	0-255	0
9	LED Color	Outer 3 Green LED intensity	0-255	0
10	LED Color	Outer 3 Blue LED intensity	0-255	0
11	LED Color	Outer 4 Red LED intensity	0-255	0
12	LED Color	Outer 4 Green LED intensity	0-255	0
13	LED Color	Outer 4 Blue LED intensity	0-255	0
14	LED Color	Outer 5 Red LED intensity	0-255	0
15	LED Color	Outer 5 Green LED intensity	0-255	0
16	LED Color	Outer 5 Blue LED intensity	0-255	0
17	LED Color	Outer 6 Red LED intensity	0-255	0
18	LED Color	Outer 6 Green LED intensity	0-255	0
19	LED Color	Outer 6 Blue LED intensity	0-255	0
20	LED Color	Outer 7 Red LED intensity	0-255	0
21	LED Color	Outer 7 Green LED intensity	0-255	0
22	LED Color	Outer 7 Blue LED intensity	0-255	0
23	LED Color	Outer 8 Red LED intensity	0-255	0
24	LED Color	Outer 8 Green LED intensity	0-255	0
25	LED Color	Outer 8 Blue LED intensity	0-255	0
		No Function	0-1	
		Strobe (slow to fast)	2-127	
26	Outer Strobe	Strobe Pulse (slow to fast)	128-170	0
		Random Strobe All (slow to fast)	171-213	
		Random Strobe 1-3 (slow to fast)	214-255	
27	LED Color	Inner 1 Red LED intensity	0-255	0
28	LED Color	Inner 1 Green LED intensity	0-255	0
29	LED Color	Inner 1 Blue LED intensity	0-255	0
30	LED Color	Inner 2 Red LED intensity	0-255	0
31	LED Color	Inner 2 Green LED intensity	0-255	0
32	LED Color	Inner 2 Blue LED intensity	0-255	0
33	LED Color	Inner 3 Red LED intensity	0-255	0
34	LED Color	Inner 3 Green LED intensity	0-255	0
35	LED Color	Inner 3 Blue LED intensity	0-255	0
36	LED Color	Inner 4 Red LED intensity	0-255	0
37	LED Color	Inner 4 Green LED intensity	0-255	0
38	LED Color	Inner 4 Blue LED intensity	0-255	0
39	LED Color	Inner 5 Red LED intensity	0-255	0
40	LED Color	Inner 5 Green LED intensity	0-255	0
41	LED Color	Inner 5 Blue LED intensity	0-255	0
42	LED Color	Inner 6 Red LED intensity	0-255	0
43	LED Color	Inner 6 Green LED intensity	0-255	0
44	LED Color	Inner 6 Blue LED intensity	0-255	0
45	LED Color	Inner 7 Red LED intensity	0-255	0
46	LED Color	Inner 7 Green LED intensity	0-255	0
47	LED Color	Inner 7 Blue LED intensity	0-255	0
48	LED Color	Inner 8 Red LED intensity	0-255	0
49	LED Color	Inner 8 Green LED intensity	0-255	0
50	LED Color	Inner 8 Blue LED intensity	0-255	0
		No Function	0-1	
		Strobe (slow to fast)	2-127	
51	Inner Strobe	Strobe Pulse (slow to fast)	128-170	0
		Random Strobe All (slow to fast)	171-213	
		Random Strobe 1-8 (slow to fast)	214-255	
52	LED Color	Center Warm White	0-255	0
53	LED Color	Center Amber	0-255	0
54	LED Color	Reflective Warm White	0-255	0
		No Function	0-1	
		Strobe (slow to fast)	2-127	
55	Center Strobe	Strobe Pulse (slow to fast)	128-170	0
		Random Strobe All (slow to fast)	171-213	
		Random Strobe 1-3 (slow to fast)	214-255	

Size and Weight

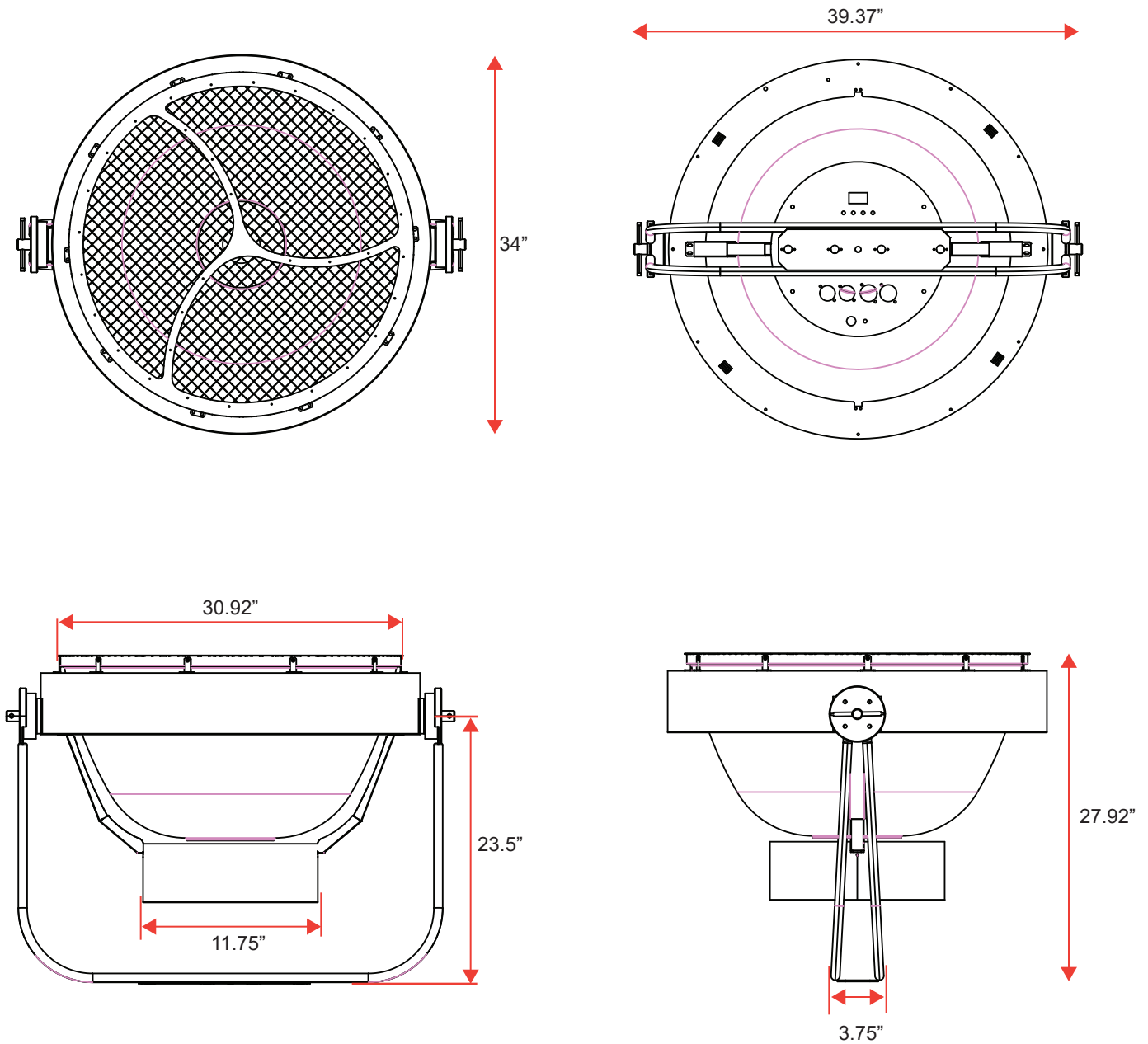

Fixture Size:	39.37" X 27.92" X 34"
Fixture Weight:	51lb
Road Case Size:	45" X 22.55" X 31.5"
Inside Road Case Weight:	151lb

Segment

Outer Circle

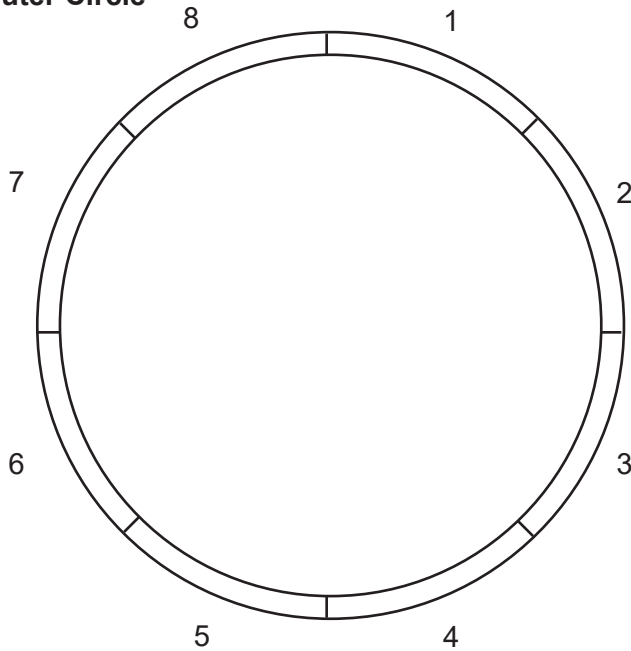

Inner Circle

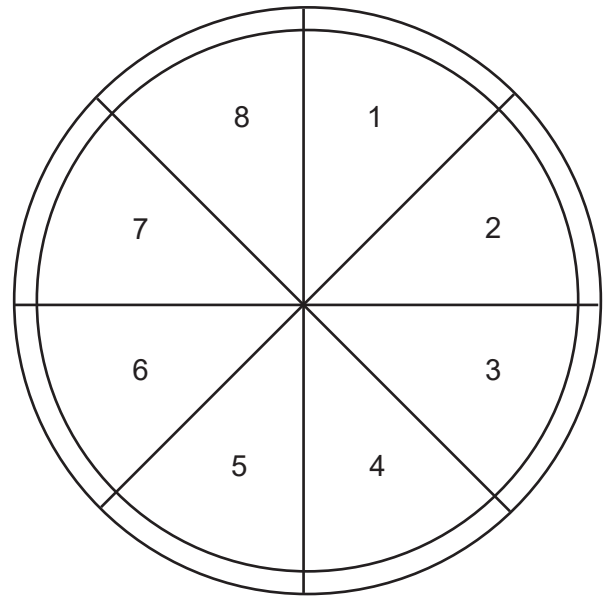

Installation

Caution!

1. The Installation must be carried out by an authorized dealer or trained professional.
2. Unit may cause severe injuries, if you have doubts concerning the safety do not install.
3. Unit is to be 24 inches away from flammable materials.
4. Use high quality installation equipment to hang the unit.
5. Internal Fan Filters must be cleaned periodically as not to block airflow.

When rigging the it is very important that you follow common safety procedures. Rigging requires extensive experience including but not limited to calculating working weight loads, material being used and periodic safety inspections. If you lack these qualifications, do not attempt the installation yourself, instead use a professional structural rigger.

When rigging the unit always be secure with a secondary safety attachment. The installation location of the fixture has got to be built in the way that it can hold 10 times the weight for 1 hour with out any failures. Installation should be checked at least one time a year by a skilled professional.

General Terms & Conditions

1. All resellers must have approved and signed Reseller Application on file, including their respective state tax information and W-9. Applications are re-evaluated on a fiscal calendar year basis to assure business integrity and tax status.
2. Cash, check, cashiers check, ACH, wire transfer, MasterCard, Visa, Discover, and American Express are accepted forms of payment.
3. Past due invoices will be charged 1.5% per month finance charge. Uncollected invoices are subject to be turned over to collection.
4. The reseller will pay all reasonable expenses incurred in the course of collections.
5. The proper venue for litigation will be Bexar County, Texas.
6. Returned checks will be charged a \$50.00 fee.
7. All prices are in U.S. Dollars.
8. All prices and specifications are subject to change without notice, sales order confirmations are emailed and will reflect correct pricing.
9. All terms are insured, monitored, analyzed and approved by Coface USA. Changes in credit line and approved terms can change without notice. Company authorization of credit is based on Coface approvals. Any conflicts or disagreements should be referred to: 650 College Rd East Suite 2005 Princeton, NJ 08540. 1-609-469-0400. E-mail: cofaceusa@coface.com
10. Returns are subject to 25% restocking charge plus any necessary charges for repair or re-packaging.

Shipping Terms & Conditions

1. All orders are EXW San Antonio, TX (EXW means that a buyer/reseller incurs the risks for bringing the goods to their final destination) any deviation needs to be done in writing.
2. UPS ground shipping is the preferred shipping method. Requests for specific carriers may require use of the customer's account number and may incur an additional charge for handling.
3. Drop shipments are subject to all return charges at resellers expense. Drop shipments are not allowed outside of the territorial United States.
4. NO C.O.D. shipments allowed.
5. Returned and undelivered shipment charges are the buyer/resellers responsibility and will be billed to the buyer/reseller.
6. The freight carrier and Company shipping@mega.lighting should be notified upon receipt of damaged freight, discrepancies, or non-conformities within 24 hours. Company can assist in making claims with carriers or agents in the event of any loss or damage.
7. Upon acceptance in good order by Carrier from Company, the material becomes the property of the Reseller.

Warranty and Service Procedures

1. All returns require an RMA# (Return Merchandise Authorization number) before returning goods for any reason. For a service or warranty RMA, please email service@mega.lighting or call (210)684-2600. For sales or demo returns, please contact sales@mega.lighting.
2. Case will be created and an RMA notice will be emailed. All units received must have the RMA # included with the unit as well as on the shipping label.
3. All shipping charges are the responsibility of the customer: MEGA Systems, Inc., Service, 18668 HWY 16 N., Helotes, TX 78023

Warranty for Products Purchased Before 2021

Unless otherwise stated in writing, product is covered by a one year parts and labor limited warranty and is subject to same limitations listed under the limited warranty exclusions listed below.

Warranty for Products Purchased After January 1, 2021

MEGA SYSTEMS INC ("MSI") hereby warrants to the original purchaser/owner (Customer"), MSI products to be free of manufacturing defects in material and workmanship, for the warranty periods as defined below from the original purchase invoice date. This warranty applies exclusively to new MSI branded and/or distributed products listed below, purchased from an MSI AUTHORIZED dealer/reseller. This warranty is not transferrable and may or may not apply to products sold and/or forwarded outside the United States. Please contact MSI for applicable regional product warranty information.

The purchase of MSI product constitutes the Customer's acceptance of all warranty terms and conditions as listed in this limited warranty statement. This warranty provides the Customer with legal rights, which may vary from state to state. Please contact MSI regarding warranty questions prior to purchasing.

Product / Series	Warranty Period	Coverage
Battery Powered LED	Six month battery, one year all other components	1, 2
Moving LED, Hazers	One Year	2
Outdoor IP-Rated LED	Two Years	3
House Light LED, Decorative LED, Compact LED, iCandy LED, Theatrical LED, Strobe Wash LED, Follow Spot LED, Production & House of Worship Control, Architectural Control, Theatrical Control, Dance Venue & Mobile DJ Control, Direct View LED Displays, and MV Controllers	Three Years	4

1. Battery: 183 days/six months 2. Parts and Labor: 365 days/one year 3. Parts and Labor: 730 days/two years 4. Parts and Labor: 1095 days/three years

This limited warranty excludes any defects caused by, resulting from, or relating to the following:
 Normal wear and tear of lamps, color media, brushes, contact rings, lamp sockets, belts and other parts prone to wear and tear.
 Misuse, abuse, improper handling, accident, alteration or attempts to repair by or on behalf of the owner or any person not authorized by MSI.
 Damage to the product resulting from acts of God, including but not limited to, earthquakes, hurricanes, tornadoes, lightning and other natural disasters, fire, explosion, flood, riots, civil disorder or any other cause beyond the reasonable control of MSI.
 Exposure to harsh or excessively corrosive environmental conditions (whether indoors or outdoors) including, but not limited to, extreme temperature, humidity, atmospheric conditions (including salinity or pressure), radiation (UV, infrared or nuclear), shock and conditions which exceed the product's Ingress Protection ("IP") rating.
 Use of the product in a manner which exceeds the applicable product specification, including, but not limited to, exposure to excessive, insufficient, or other voltage conditions.
 Installation or use of the product not in accordance with the technical documentation, MSI guidelines (as may be posted on its website at www.megasystemsinc.com from time to time or otherwise designated by MSI or its brands) or applicable building and electrical codes, regulations, and standards.
 Failure to maintain the product in accordance with the technical documentation.
 Natural degradation and color shift of the LED source over the course of normal product use.
 Slight deviations in the specified values of intensity and color that do not affect the functionality of the product.
 Use of the product not for its intended purpose.

All warranty claims are evaluated under the terms of this limited warranty. If a product falls within the warranty period and if, upon examination by MSI, it is found to have failed for a covered cause, MSI will, at its sole discretion, repair or replace the defective part or product or reimburse the purchaser a pro-rated portion of the purchase price based on the percentage of the warranty period still remaining as of the date that the returned product was received by MSI. Should a replacement part or product be discontinued or unavailable, MSI reserves the right, in its sole and absolute discretion, to substitute a comparable replacement part or product for the defective part of product. MSI warranty obligation herunder is limited solely to the repair or replacement of or reimbursement for the particular parts or products determined by MSI to have failed for a covered cause within the warranty period. In no event shall MSI be responsible to replace or reimburse purchaser for any products or portions of a system that MSI determines has not failed for a covered cause within the warranty period, even if such other products or portions of a system are used together with products being repaired or replaced by MSI under this warranty and the repaired product differs in brightness, colors or any other attribute after the repair.

Costs of removal, shipping to MSI or its authorized representative and reinstallation are solely the responsibility of the purchaser. If MSI determines that the product is covered by this limited warranty, it will only pay for parts and labor as indicated by product type. If MSI determines that the product is not covered by this limited warranty, the purchaser will have the option of paying for the repair if the product can be repaired and the purchaser shall be responsible for the cost of shipping the repaired product back to the purchaser. MSI reserves the right, in its sole and absolute discretion, to decline any repair.

IN NO EVENT SHALL MEGA SYSTEMS, INC. BE LIABLE FOR ANY INCIDENTAL, CONSEQUENTIAL, SPECIAL, INDIRECT OR PUNITIVE LOSS OR DAMAGE OF ANY KIND, INCLUDING, BUT NOT LIMITED TO, LOSS OF PROFITS OR REVENUES, LOSS OF USE OF THE PRODUCT OR ANY OTHER GOODS OR ASSOCIATED EQUIPMENT, DAMAGE TO ANY ASSOCIATED EQUIPMENT, COST OF CAPITAL, COST OF SUBSTITUTE PRODUCTS, FACILITIES OR SERVICES, DOWN TIME COST, INSTALLATION OR LABOR COSTS, OR CLAIMS OF THE PURCHASER'S CUSTOMERS, WHETHER BASED ON WARRANTY, CONTRACT OR NEGLIGENCE, ARISING IN CONNECTION WITH THE SALE, USE OR REPAIR OF THE PRODUCT. MEGA SYSTEMS INC'S MAXIMUM LIABILITY SHALL NOT, IN ANY CASE, EXCEED THE PURCHASE PRICE OF THE PRODUCT THAT GIVES RISE TO THE CLAIM.

EXCEPT FOR THE LIMITED WARRANTY SET FORTH HEREIN, ALL PRODUCTS SOLD BY MEGA SYSTEMS, INC. ARE SOLD "AS IS" WITHOUT ANY WARRANTY, EXPRESS, OR IMPLIED, STATUTORY OR OTHERWISE, INCLUDING, BUT NOT LIMITED TO, IMPLIED WARRANTIES OR MERCHANTABILITY AND FITNESS FOR A PARTICULAR PURPOSE, ALL OF WHICH ARE EXPRESSLY AND SPECIFICALLY DISCLAIMED BY MEGA SYSTEMS, INC.

Customer Support

Mega Lite has a customer support line to provide set-up help and to answer any questions should you encounter a problem. Please visit our website for any other related technical documents. For service related issues, please contact our service dept.

Monday - Friday 9am to 6pm CST
(210)684-2600
Service@mega.lighting

Manual Version

Please visit www.mega.lighting for the most up-to-date manual version.

Manual Version	Date	Fixture Software	Notes
1.0	5/30/2024	1.0.0	



MEGA LITE
18662 Bandera Rd
Helotes, TX 78023
Phone (210)684-2600 / Fax (210)855-6279
www.mega.lighting / info@mega.lighting